

Correct use

Safety switches series SLK are interlocking devices with guard locking (separate actuator).

In combination with a movable safety guard and the machine control, this safety component prevents the safety guard from being opened while a dangerous machine function is being performed.

This means:

- ▶ Starting commands that cause a dangerous machine function must become active only when the safety guard is closed and locked.
- ▶ The guard locking device must not be unlocked until the dangerous machine function has ended.
- ▶ Closing and locking a safety guard must not cause automatic starting of a dangerous machine function. A separate start command must be issued. For exceptions, refer to EN ISO 12100 or relevant type C standards.

Before the device is used, a risk assessment must be performed on the machine, e.g. in accordance with the following standards:

- ▶ EN ISO 13849-1, Safety of machinery – Safety-related parts of control systems – Part 1: General principles for design
- ▶ EN ISO 12100, Safety of machinery – General principles for design – Risk assessment and risk reduction
- ▶ IEC 62061, Safety of machinery – Functional safety of safety-related electrical, electronic and programmable electronic control systems

Correct use includes observing the relevant requirements for installation and operation, particularly based on the following standards:

- ▶ EN ISO 13849-1, Safety of machinery – Safety-related parts of control systems – Part 1: General principles for design
- ▶ EN ISO 14119 (supersedes EN 1088), Safety of machinery – Interlocking devices associated with guards – Principles for design and selection
- ▶ EN 60204-1, Safety of machinery – Electrical equipment of machines – Part 1: General requirements

Important!

- ▶ The user is responsible for the proper integration of the device into a safe overall system. For this purpose, the overall system must be validated, e.g. in accordance with EN ISO 13849-2.
- ▶ If the simplified method according to section 6.3 of EN ISO 13849-1:2008 is used for determining the Performance Level (PL), the PL might be reduced if several devices are connected in series.
- ▶ Logical series connection of safe contacts is possible up to PL d in certain circumstances. More information about this is available in ISO TR 24119.
- ▶ If a product data sheet is included with the product, the information on the data sheet applies in case of discrepancies with the operating instructions.

Safety precautions

⚠ WARNING

Danger to life due to improper installation or due to bypassing (tampering). Safety components perform a personal protection function.

- ▶ Safety components must not be bypassed, turned away, removed or otherwise rendered ineffective. On this topic pay attention in particular to the measures for reducing the possibility of bypassing according to EN ISO 14119:2013, section 7.
- ▶ The switching operation must be triggered only by actuators designated for this purpose.

- ▶ Prevent bypassing by means of replacement actuators. For this purpose, restrict access to actuators and to keys for releases, for example.
- ▶ Mounting, electrical connection and setup only by authorized personnel possessing special knowledge about handling safety components.

⚠ CAUTION

Danger due to high housing temperature at ambient temperatures above 40 °C.

- ▶ Protect switch against touching by personnel or contact with inflammable material.

Function

The safety switch permits the locking of movable safety guards.

In the switch head there is a rotating cam that is blocked/released by the guard locking pin.

The guard locking pin is moved on the insertion/removal of the actuator and on the activation/release of the guard locking. During this process the switching contacts are actuated.

If the cam is blocked (guard locking active), the actuator cannot be pulled out of the switch head. For design reasons, guard locking can be activated only when the safety guard is closed (failsafe locking mechanism).

Position monitoring of the safety guard and monitoring of interlocking are performed via two separate switching elements (see Figure 1).

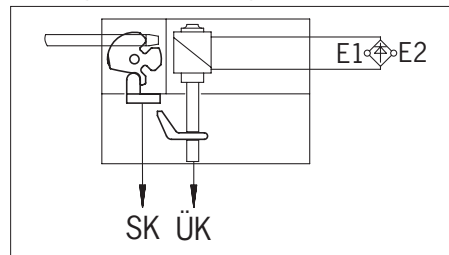

Figure 1: Function of safety switch SLK

The safety switch is designed so that fault exclusions for internal faults in accordance with EN ISO 13849-2:2013, Table A4, can be assumed.

Guard lock monitoring

All versions feature at least one safe contact for monitoring guard locking. The contacts are opened when guard locking is released.

Door monitoring contact

All versions additionally feature at least one door monitoring contact. Depending on the switching element, the door monitoring contacts can be either positively driven (contacts) or not positively driven.

The door monitoring contacts are actuated when the safety guard is opened.

Version SLK-M

(guard locking actuated by spring force and released by energy ON)

- ▶ Activating guard locking: close safety guard; no voltage at the solenoid
- ▶ Releasing guard locking: apply voltage to the solenoid

The spring-operated guard locking functions in accordance with the closed-circuit current principle. If voltage is interrupted at the solenoid, guard locking remains active and the safety guard cannot be opened directly.

If the safety guard is open when the power supply is interrupted and the guard is then closed, guard locking is activated. This can lead to persons being locked in unintentionally.

Version SLK-E

(guard locking actuated by energy ON and released by spring force)

Important!

Use as guard locking for personnel protection is possible only in special cases, after strict assessment of the accident risk (see EN ISO 14119:2013, Section 5.7.1!)

- ▶ Activating guard locking: apply voltage to the solenoid
- ▶ Releasing guard locking: disconnect voltage from the solenoid

The magnetically actuated guard locking operates in accordance with the open-circuit current principle. If the voltage at the solenoid is interrupted, the guard locking is released and the safety guard can be opened directly!

Switching states

The detailed switching states for your switch can be found in Figure 3. All available switching elements are described there.

Safety guard open

SLK-M and SLK-E:

The safety contacts and are open.

Safety guard closed and not locked

SLK-M and SLK-E:

The safety contacts are closed. The safety contacts are open.

Safety guard closed and locked

SLK-M and SLK-E:

The safety contacts and are closed.

Selection of the actuator

NOTICE

Damage to the device due to unsuitable actuator. Make sure to select the correct actuator (see table in Figure 5).

Additionally pay attention to the door radius and the fastening options (see Figure 4).

The following versions are available:

- ▶ Actuator S for safety switches without insertion funnel.
- ▶ Actuator F for safety switches with insertion funnel.

Manual release

Some situations require guard locking to be released manually (e.g. malfunctions or an emergency). A function test should be performed after release.

More information on this topic can be found in the standard EN ISO 14119:2013, section 5.7.5.1. The device can feature the following release functions:

Auxiliary release

In the event of malfunctions, the guard locking can be released with the auxiliary release irrespective of the state of the solenoid.

The contacts are opened when the auxiliary release is actuated. A stop command must be generated with these contacts.

Actuating auxiliary release

1. Unscrew locking screw.
 2. Using a screwdriver, turn the auxiliary release to in the direction of the arrow.
- ➔ Guard locking is released.

Important!

- ▶ The actuator must not be under tensile stress during manual release.
- ▶ After use, reset the auxiliary release and screw in and seal the locking screw (for example with sealing lacquer).

Auxiliary release with triangular key

Function as for auxiliary release.

Important!

- ▶ The actuator must not be under tensile stress during manual release.

Mounting

NOTICE

Device damage due to improper mounting and unsuitable ambient conditions

- ▶ Safety switches and actuators must not be used as an end stop.
- ▶ Observe EN ISO 14119:2013, sections 5.2 and 5.3, for information about fastening the safety switch and the actuator.
- ▶ Observe EN ISO 14119:2013, section 7, for information about reducing the possibilities for bypassing an interlocking device.
- ▶ Protect the switch head against damage as well as penetrating foreign objects such as swarf, sand and blasting shot, etc.

Changing the actuating direction

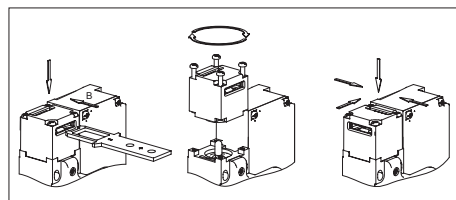

Figure 2: Changing the actuating direction

1. Remove the screws from the actuating head.
2. Set the required direction.
3. Tighten the screws with a torque of 0.8 Nm.
4. Cover the unused actuating slot with the enclosed slot cover.

Electrical connection

⚠ WARNING

Loss of the safety function due to incorrect connection.

- ▶ Use only safe contacts (⊖ and ⊕) for safety functions.
- ▶ When choosing the insulation material and wire for the connections, pay attention to the required temperature resistance and the max. mechanical load!

Use of the safety switch as guard locking for personnel protection

At least one contact ⊕ must be used. It signals the guard locking state (for terminal assignment, see Figure 3).

Use of the safety switch as guard locking for process protection

At least one contact ⊖ must be used. Contacts with the ⊕ symbol can also be used (for terminal assignment, see Figure 3).

The following information applies to devices with cable entry:

1. Use a suitable tool to open the desired insertion opening.
2. Fit the cable gland with the appropriate degree of protection.
3. Connect and tighten the terminals with 0.5 Nm (for terminal assignment, see Figure 3).
4. Check that the cable entry is sealed.
5. Close the switch cover and screw in place (tightening torque 0.8 Nm).

Function test

⚠ WARNING

Fatal injury due to faults during the function test.

- ▶ Before carrying out the function test, make sure that there are no persons in the danger area.
- ▶ Observe the valid accident prevention regulations.

Check the device for correct function after installation and after every fault.

Proceed as follows:

Mechanical function test

The actuator must slide easily into the actuating head. Close the safety guard several times to check the function. The function of any manual releases (except for the auxiliary release) must also be tested.

Electrical function test

1. Switch on operating voltage.
2. Close all safety guards and activate guard locking.
 - ➔ The machine must not start automatically.
 - ➔ It must not be possible to open the safety guard.
3. Start the machine function.
 - ➔ It must not be possible to release guard locking as long as the dangerous machine function is active.
4. Stop the machine function and release guard locking.
 - ➔ The safety guard must remain locked until there is no longer any risk of injury (e.g. due to movements with overtravel).
 - ➔ It must not be possible to start the machine function as long as guard locking is released.

Repeat steps 2 - 4 for each safety guard.

Inspection and service

⚠ WARNING

Danger of severe injuries due to the loss of the safety function.

- ▶ If damage or wear is found, the complete switch and actuator assembly must be replaced. Replacement of individual parts or assemblies is not permitted.
- ▶ Check the device for proper function at regular intervals and after every fault. For information about possible time intervals, refer to EN ISO 14119:2013, section 8.2.

Inspection of the following is necessary to ensure trouble-free long-term operation:

- ▶ correct switching function
- ▶ secure mounting of all components
- ▶ damage, heavy contamination, dirt and wear
- ▶ sealing of cable entry
- ▶ loose cable connections or plug connectors.

Information: The year of manufacture can be seen in the bottom, right corner of the type label.

Exclusion of liability and warranty

In case of failure to comply with the conditions for correct use stated above, or if the safety instructions are not followed, or if any servicing is not performed as required, liability will be excluded and the warranty void.

Notes about cULus

The following information applies to devices with cable entry:

For use and applications as per the requirements of cULus, a copper wire for the temperature range 60/75 °C is to be used.

EC declaration of conformity

The manufacturer named below herewith declares that the product fulfills the provisions of the directive(s) listed below and that the related standards have been applied.

Torino, 25/01/2017

ReeR S.p.A.
32 via Carcano
10153 Torino Italia

Directives applied:

- ▶ Machinery directive 2006/42/EC

Standards applied:

- ▶ EN 60947-5-1:2004 + Cor.:2005 + A1:2009
- ▶ EN 1088:1995+A2:2008
- ▶ EN 14119:2013

Carlo Pautasso
Direttore Tecnico
Technical Director

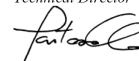

Simone Scaravelli
Amministratore Delegato
Managing director

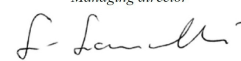

Service

If service support is required, please contact:

ReeR S.p.A.
32 via Carcano
10153 - Torino - Italia

Service telephone:

+39/0112482215

Fax:

+39/011859867

E-mail:

info@reer.it

aftersales@reer.it

Internet:

www.reer.it

Technical data

| Parameter | Value |
|---------------------------------------------------------------------|--------------------------------------------------------|
| Housing material | Reinforced thermoplastic |
| Degree of protection acc. to IEC 60529 | IP67 |
| Mechanical life | 2 x 10 ⁶ operating cycles |
| Ambient temperature | -20 ... +55 °C |
| Degree of contamination (external, acc. to EN 60947-1) | 3 (industrial) |
| Installation position | Any |
| Approach speed, max. | 20 m/min |
| Extraction force (not locked) | 30 N |
| Actuating force max. at 20 °C | 35 N |
| Actuation frequency | 1200/h |
| Switching principle | Slow-action switching contact |
| Contact material | Silver alloy, gold flashed |
| Connection | Cable entry M20 x 1.5 |
| Conductor cross-section (flexible/rigid) | 0.34 ... 1.5 mm ² |
| Rated insulation voltage | U _i = 250 V |
| Rated impulse withstand voltage | U _{imp} = 2.5 kV |
| Conditional short-circuit current | 100 A |
| Switching voltage, min., at 10 mA | 12 V |
| Utilization category acc. to EN 60947-5-1 | AC-15 4 A 230 V / DC-13 4 A 24 V |
| Switching current, min., at 24 V | 1 mA |
| Short circuit protection (control circuit fuse) acc. to IEC 60269-1 | 4 A gG |
| Conv. thermal current I _{th} | 4 A |
| Solenoid operating voltage/ solenoid power consumption | AC/DC 24 V (+10%/-15%) 6 W AC 230 V (+10%/-15%) 6 W |
| Duty cycle | 100 % |
| Locking force F _{max} | |
| SLK plastic head | ≥ 1000 N |
| SLK metal head | ≥ 2000 N |
| With angled actuator | 1500 N |
| Locking force F _{zh} acc. to EN ISO 14119 | ($F_{zh} = \frac{F_{max}}{1.3}$) |
| SLK plastic head | 700 N |
| SLK metal head | 1500 N |
| Reliability values acc. to EN ISO 13849-1 | |
| B _{10d} at DC-13 100 mA/24V | 2 x 10 ⁶ |

Shown: safety guard closed, actuator locked.
NC contact opens before NO contact closes (break before make).

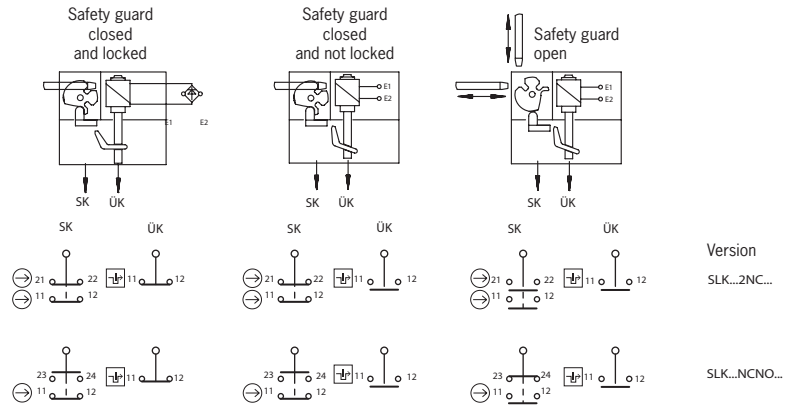

Figure 3: Switching elements and switching functions

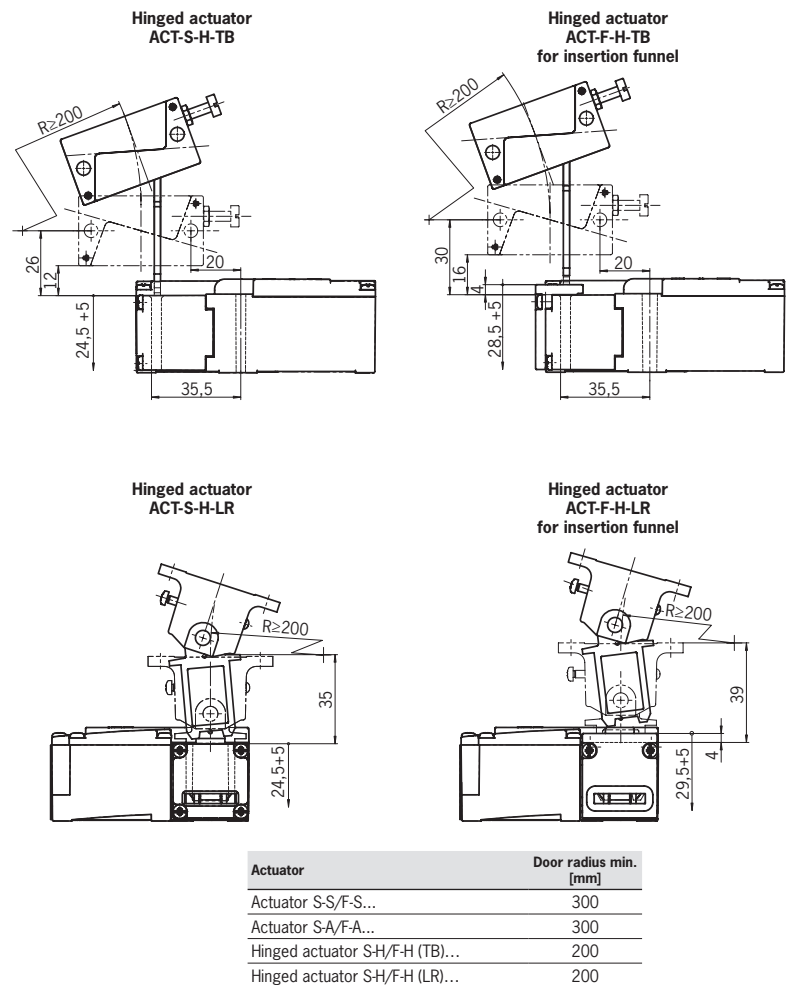

Figure 4: Minimum door radii

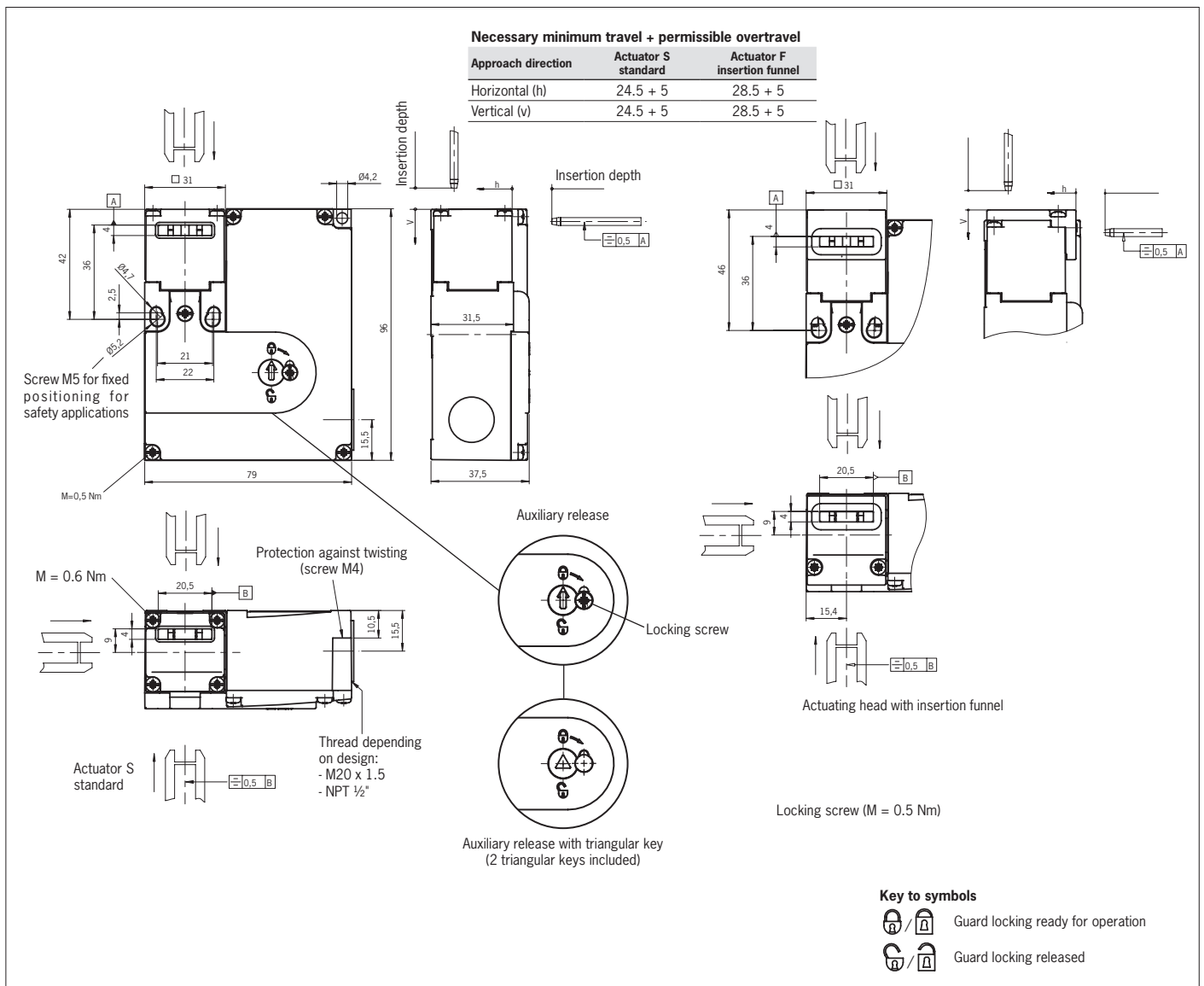

Figure 5: Dimension drawing SLK... without insertion funnel and SLK... with insertion funnel

